

IJERT - Full Jurnal 131\_20519-  
IJERT\_DECEMBER ISSUE ok  
5005-5011.pdf  
*by*

---

**Submission date:** 29-Sep-2022 03:24PM (UTC+0700)

**Submission ID:** 1911966961

**File name:** IJERT - Full Jurnal 131\_20519-IJERT\_DECEMBER ISSUE ok 5005-5011.pdf (893.46K)

**Word count:** 3114

**Character count:** 16792

## 2 Development of a Monitoring System Automatic Power Meter at the "Gunung Salak" Geothermal Power Plant, Sukabumi, Indonesia

Muhamad Muslih<sup>1\*</sup>, Nunik Destria Arianti<sup>2</sup>, Somantri<sup>3</sup>,

<sup>1,2</sup>Department of Information System, Nusa Putra University, Indonesia.

<sup>3</sup>Department of Informatics Engineering, Nusa Putra University, Indonesia.

\*Corresponding author: muhamad.muslih@nusaputra.ac.id

### Abstract

kWh meter is a tool measuring device used in PT Indonesia geothermal power plant "Gunung Salak" to measure the energy generated generator and its auxiliary engine equipment. kWh meter devices connect with the LAN network so that it can be remotely accessed through the corporate network. The protocol used to access kWh meter data is Modbus TCP and HTTP. Access to the Modbus TCP protocol has a limited number of users. With the corporate Server Central office's presence on standby to fetch data in real-time, access via Modbus protocol is often impossible. One alternative is using the HTTP protocol. To access kWh meters via HTTP protocol can be done using a web browser. The operation field requires real-time data on kWh meters for plant condition monitoring and generation monitoring. With a large amount of kWh meter, the time it takes to perform data retrieval at all meters when using a web browser for longer, this becomes less effective as the data cannot be accessed simultaneously. Automatic meter reading application is one of the solutions used as a bridge to access multiple kWh meters simultaneously. By implementing parallel computing with a multithreading method, searching and retrieving data is faster so that the data displayed in the client application corresponds to the real-time data on the measuring instrument kWh meter.

**Keywords:** appropriate technology, geothermal power plant, Indonesia, monitoring.

### I. INTRODUCTION

With its ring of fires, Indonesia has a lot of geothermal reserves that can be used as renewable power plants [1-4]. One of them is a geothermal power plant located on "Gunung Salak" (Sukabumi, West Java, Indonesia) with three generator units [5]. The generator's amount of electrical power is measured using a PowerLogic ION meter and a Power Quality meter. This tool is also used to calculate the power distribution and electricity consumption of generator auxiliary equipment [6]. In use, the tool is connected to a LAN network so that it can be accessed remotely using a web browser and ION client application. Currently, the number of measuring instruments is 11 units.

Several data on generators' power in geothermal power plants are needed to carry out the power plant's monitoring process. Data from monitoring a system is critical to make the right decision [7-10]. Therefore, an operator will continuously record the power generated every 30 minutes. Manual recording is done by viewing the amount of power displayed by the PowerLogic ION meter screen or accessing it through

the KWH meter IP Address. However, the data recorded by the operator is not uniform because it has to be recorded manually at the same time for all measuring instruments installed in each generator. Besides, for reading via IP Address, a web page loading process is required, which adds to uneven data recording time.

To improve the quality of data obtained from the geothermal power generator located on "Gunung Salak", a data monitoring system was developed. Therefore, this paper aims to develop a power measurement system at the "Gunung Salak" geothermal power plant (Sukabumi, West Java, Indonesia), which was previously based on a LAN network to become a parallel computing mobile application based. This application is expected to automatically read real-time power data and simultaneously fill in the log sheet data according to a predetermined time.

### II. MATERIAL AND METHOD

The system development used in this study uses an Agile-development approach. Agile development is a concept used by several researchers [11-13] in developing an application system. Agile-development is a combination of incremental and iterative methods. Agile-development is an iterative process with short cycles. Needs are planned, implemented, tested, and repeatedly evaluated in a shorter period. The implication of using agile software development is high adaptability to changes during the software development process.

Testing of the developed system is carried out using the black box testing method [14-16]. The parameters analyzed are in the form of functional testing and usability testing of the system. Functional testing is demonstrated by suitability, accuracy, security, and compliance. Usability testing is indicated by learnability, efficiency, memorability, error, and satisfaction from the user questionnaire [17]. The weights of the usability test are presented in Table 1.

Table 1. Usability test weights of the developed system

No	Code	Abbreviation	Score
1	STS	Strongly Disagrees	1
2	TS	Disagree	2
3	KS	Middle disagreed	3
4	S	Agree	4
5	SS	Strongly Agree	5

The first step in usability testing is giving the user a pre-prepared task. These tasks were given to 14 employees who

were familiar with the automatic meter reading application so that they did not have difficulty doing these tasks. These tasks are used as a means of interaction in measuring usability.

The research was conducted at the “Gunung Salak” geothermal power plant, Sukabumi, West Java, Indonesia. This plant has 3 generators with a power capacity of 60 MW each. Each generating machine is equipped with a power meter measuring device to measure Gross power, Net power, own power consumption, and star energy own use power. The data input activity diagram for reporting on the old system is presented in Figure 1. The measuring points of the power meter are presented in Figure 2.

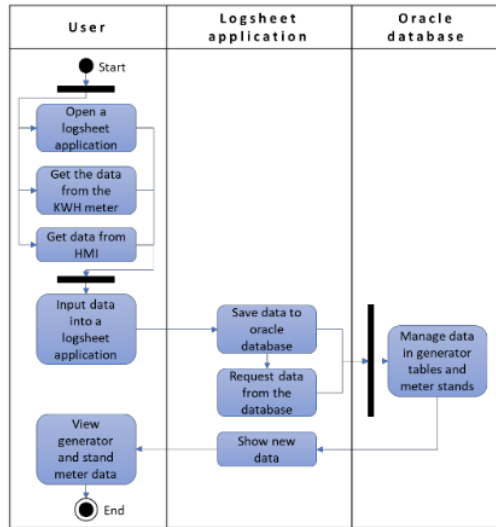

Figure 1. Activity diagram of old system data input

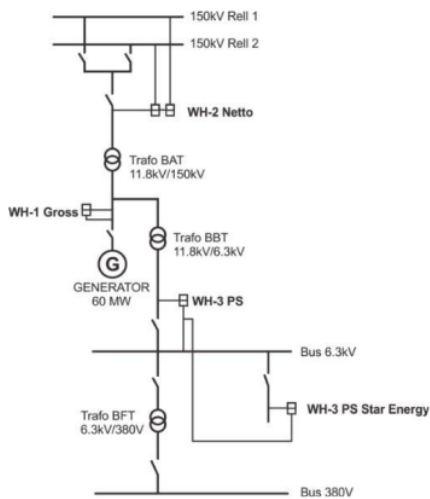

Figure 2. The point of measuring the power on the generator uses a power meter

### III. RESULT AND DISCUSSION

#### III.I Activity Diagram of the System being Developed

The application developed consists of a mobile android based application for monitoring systems and a windows-based application for automatic data retrieval and recording for datasheet recording. This automatic power monitoring system application is connected to a power meter via a LAN network. The application will perform real-time data retrieval via the HTTP protocol from the On-board web server power meter. The activity diagram of the system developed is presented in Figure 3. The system developed is related to changes from the KWH meter data reading method, displaying real-time working generators, and sending stand meter data to the network. Furthermore, the data update will be carried out automatically by the system being built.

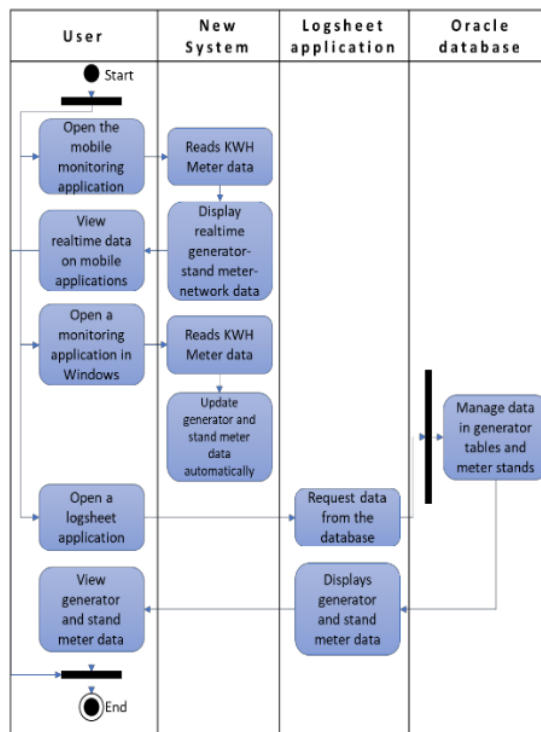

Figure 3. Activity diagram of the system being developed

#### III.II Use Case Diagram

The application developed consists of two bases, namely android based and windows based. Users have access to all application features. Features that users can access on the android application are info, generator real-time data, real-time power data, and PLN P2B real-time data. Features that can be accessed through a windows base are info, real-time generator data, real-time power data, and oracle data logger (Figure 4).

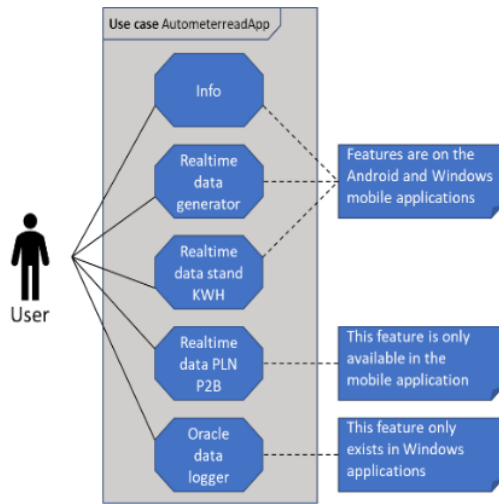
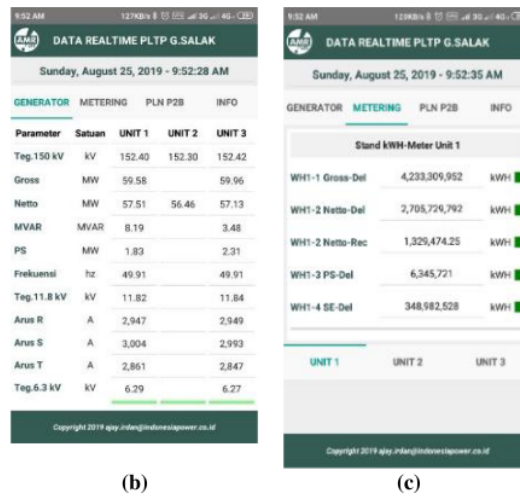

Figure 4. Use case diagram

### III.III Applications on Android

The application interface is presented in Figure 5. This application will display the company logo for 5 seconds the first time it is run. After that, the application will enter the info page, which contains the application logo and a list of application features. The ENTER button is used to enter the main monitoring page and the QUIT button to exit the application. The generator tab is the default tab, which will always be displayed when entering the monitoring main page. The application will retrieve the generator loading data of 1-2-3 units from the power meter in real-time every second.



(b)

(c)



(d)



(a)

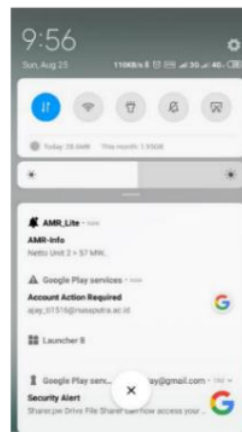

(e)

Figure 5. Screenshot of program (a) front page (b) generator menu (c) metering menu (d) PLN P2B menu (e) notification menu

### III.IV Application on a Web Browser

When the Oracle data logger tab (Figure 6) is selected on the main menu, it will display connect and disconnect buttons. The button is to run a test connection to the Oracle database server. Besides, this button will also instruct the system to update the generator load history data and the meter stand. The test button is used to perform test data updates and clear logs from the database update log data.

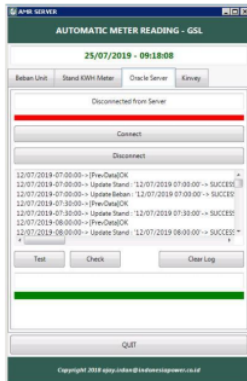
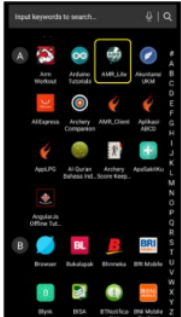



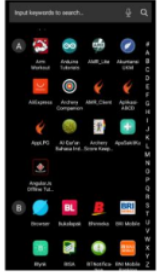





Figure 6. Oracle server menu display of the application

### III.V Testing the system being developed

The results of the suitability test of the developed system are presented in Table 2. The suitability test is carried out to observe the software's ability to provide a series of functions suitable for specific tasks and objectives of the user [18]. The test results using five special scenarios indicate that the developed system is valid in executing the scenario ordered. This shows the system is suitable for executing commands from the user.

Table 2. The result of the suitability parameter test of the application

No	Case scenario	Finding	Result
1	Open the application from the test android smartphone	The splash screen appears and enters the info page	approve
			

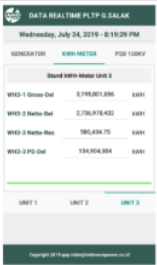
2	Exit the application by pressing the QUIT button	The application closes and returns to the smartphone menu	approve
			
3	Enter the main page by pressing the ENTER button	The page moves to the main page, with the generator tab default view	approve
			
4	Select the generator tab while the tab selector is in another position	The generator tab displays 1-2-3 unit loading data	approve
			
5	In the kwh meter tab, select the unit tab 3	The display will move the unit 3 tab page and display the data stand unit 3	approve
			

The accuracy testing of the developed system is presented in Table 3. System accuracy is related to the system device's ability to provide precise and correct results according to the needs of the user [19]. Testing the accuracy using a special scenario shows that the system being developed is valid in executing the scenario ordered. This shows that the system is correct in carrying out the instructions from the user.

**Table 3.** The accuracy parameter test result from the application

Case scenario	Finding	Result
Check the PLN P2B network condition data	Data by the PLN P2B Webserver	approve

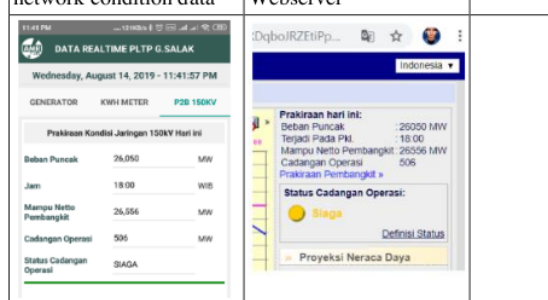

The security test of the developed system is presented in Table 4. A security test is a test to see the software's ability to prevent unwanted access, deal with intruders, and authorize data modification [20]. System security testing results using four specific test scenarios indicate that the system being developed is valid in executing the ordered scenario. This shows the system is safe in carrying out instructions from the user.

**Table 4.** Security parameter test results from the application

No	Case scenario	Finding	Result
1	Open applications without VPN	Data on the generator tab will not be displayed	approve
2	Open applications without VPN	The data on the kwh meter tab will not be displayed	approve



3	Open applications without VPN	Data on the P2B PLN tab will not be displayed	Approve
4	Open applications with VPN	Data on the P2B PLN tab will be displayed	approve

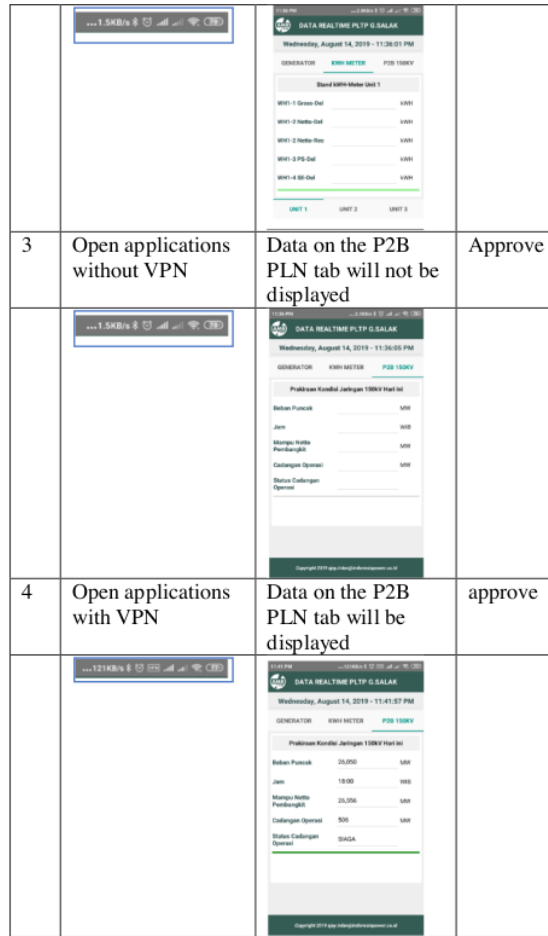

Compliance testing of the developed system is presented in Table 5. The system's compliance test shows the system's ability to meet standard requirements following applicable regulations [21]. Using a special scenario, the test results show that the system being developed is valid in executing the ordered scenario. This shows that the system is correct in carrying out the instructions from the user.

**Table 5.** The results of the compliance parameter test from the application

Case scenario	Finding	Result
The function of the Android-based automatic kwh meter realtime monitoring system application	All functions in the application can be used and run well	approve

The complete usability results are presented in Figure 6. The smallest attribute value is in the automatic meter reading server's performance aspect, which is 3.80, and the most massive attribute value is in the aspect of ease of recognition and operation, which is 4.27. All attributes have a user acceptance value greater than 3, with an average value of 4.05

from a scale of 5. This illustrates that the monitoring system developed has excellent usability aspects based on the criteria also used by Ferré, et al. [22].

**Table 6.** The score of respondents from the developed application

No	Questions	Value
<b>System aspect</b>		
1	Is the appearance of the AMR application easy to recognize?	4.27
2	Is the AMR application easy to operate?	4.27
3	Are the colors on the AMR comfortable to see?	3.93
4	Does the displayed data match what is needed?	3.93
5	Is the information provided easy to understand?	4.07
<b>User aspect</b>		
1	Is this application comfortable to use?	4.20
2	Is the writing on the application easy to read?	4.13
3	Is this application easy to download?	4.13
4	Does AMR Server make it easier to record kWh Meter data?	4.13
5	Is the AMR server performance as expected?	3.80
<b>The interaction aspect</b>		
1	Is the menu on the application easily accessible?	4.07
2	Is the response of this application as expected?	3.93
3	Are the menus and displays in the application easy to remember?	3.87
4	Are the features of this application working correctly?	3.87
5	Is this application easy to learn?	4.13

The results of a more in-depth analysis of the respondent's assessment are presented in Figure 7. The results show that 60% of respondents strongly agree, 37% agree, and 3% disagree with using the developed system. In general, it can be concluded that the level of respondent satisfaction from the use of this developed monitoring system is 86.76%.

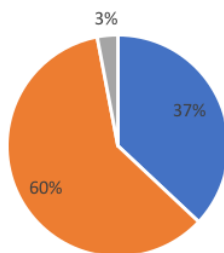

**Figure 7.** Recapitulation of respondents on the usability of the developed application

## VI. CONCLUSION

The development of a monitoring system automatic power meter at the "Gunung Salak" geothermal power plant has been developed. This system is named AMR Lite, which is intended to meet a geothermal power plant's operational data information needs on "Gunung Salak", Sukabumi, Indonesia. The onboard webserver feature on the KWH Meter Power Logic ION 8600 as an application data source is quite effective in supporting the system being developed. The automatic KWH meter monitoring application can present operational data from the KWH meter device in realtime.

## REFERENCES

- [1] N. A. Pambudi, "Geothermal power generation in Indonesia, a country within the ring of fire: Current status, future development and policy," *Renewable and Sustainable Energy Reviews*, vol. 81, pp. 2893-2901, 2018.
- [2] R. Adiprana and E. Y. Izzuddin, "Gunung salak geothermal power plant experience of scaling/deposit: analysis, root cause and prevention," in *Proceedings World Geothermal Congress*, 2010, pp. 25-29.
- [3] R. Bertani, "Geothermal power generation in the world 2005–2010 update report," *geothermics*, vol. 41, pp. 1-29, 2012.
- [4] A. Fauzi, S. Bahri, and H. Akuanbatin, "Geothermal development in Indonesia: an overview of industry status and future growth," in *Proc. World Geothermal Congress*, 2000.
- [5] A. P. Kurniawan, "Analisis pengaruh temperatur air masuk kondensor terhadap efisiensi turbin pembangkit listrik tenaga panas bumi (PLTP) Gunung Salak," Universitas Mercu Buana Jakarta, 2020.
- [6] C. M. Moraru, C. Bucur, I. Stefan, and O. Balteanu, "PowerView monitoring system for instant power consumption in tritium separation technological installations," in *Proceedings of the 5th WSEAS international conference on Circuits, systems and signals*, 2011, pp. 57-61.
- [7] A. Sitorus, N. Novrinaldi, and R. Bulan, "Non-invasive moisture content measurement system based on the ESP8266 microcontroller," *Bulletin of Electrical Engineering and Informatics*, vol. 9, pp. 924-932, 2020.
- [8] M. Masood Ahmad and F. Ullah Khan, "Two degree of freedom vibration based electromagnetic energy harvester for bridge health monitoring system," *Journal of Intelligent Material Systems and Structures*, p. 1045389X20959459, 2020.
- [9] S. A. Jumaat, M. N. A. M. Said, and C. R. A. Jawa, "Dual axis solar tracker with IoT monitoring system using arduino," *International Journal of Power Electronics and Drive Systems*, vol. 11, p. 451, 2020.
- [10] D. L. Hakim, A. G. Abdullah, and Y. Mulyadi, "SCADA application for geothermal power plant," *Journal of Engineering Science and Technology*, vol. 15, pp. 1018-1031, 2020.

- [11] J. Chóliz, J. Vilas, and J. Moreira, "Independent security testing on agile software development: a case study in a software company," in *2015 10th International Conference on Availability, Reliability and Security*, 2015, pp. 522-531.
- [12] M. E. Moreira, *Being agile: your roadmap to successful adoption of agile*: Apress, 2013.
- [13] T. H. M. De Oliveira, M. Painho, V. Santos, O. Sian, and A. Barriguinha, "Development of an agricultural management information system based on Open-Source solutions," *Procedia Technology*, vol. 16, pp. 342-354, 2014.
- [14] M. E. Khan and F. Khan, "A comparative study of white box, black box and grey box testing techniques," *Int. J. Adv. Comput. Sci. Appl.*, vol. 3, 2012.
- [15] M. E. Khan, "Different approaches to black box testing technique for finding errors," *International Journal of Software Engineering & Applications*, vol. 2, p. 31, 2011.
- [16] B. Tyler and N. Soundarajan, "Black-box testing of grey-box behavior," in *International Workshop on Formal Approaches to Software Testing*, 2003, pp. 1-14.
- [17] S. H. Lee, "Usability testing for developing effective interactive multimedia software: Concepts, dimensions, and procedures," *Journal of Educational Technology & Society*, vol. 2, 1999.
- [18] J. M. Beaver, G. A. Schiavone, and J. S. Berrios, "Predicting software suitability using a bayesian belief network," in *Fourth International Conference on Machine Learning and Applications (ICMLA'05)*, 2005, p. 7 pp.
- [19] M. Jorgensen, "Experience with the accuracy of software maintenance task effort prediction models," *IEEE Transactions on software engineering*, vol. 21, pp. 674-681, 1995.
- [20] F. G. Tompkins and R. S. Rice, "Integrating security activities into the software development life cycle and the software Quality assurance process," *Computers & Security*, vol. 5, pp. 218-242, 1986.
- [21] S.-x. SUN, X.-g. QIU, and K.-d. HUANG, "Research on Federate Compliance Test Software," *Computer Simulation*, vol. 20, pp. 86-89, 2003.
- [22] X. Ferré, N. Juristo, H. Windl, and L. Constantine, "Usability basics for software developers," *IEEE software*, vol. 18, pp. 22-29, 2001.



ORIGINALITY REPORT

---

9%

SIMILARITY INDEX

8%

INTERNET SOURCES

5%

PUBLICATIONS

6%

STUDENT PAPERS

---

PRIMARY SOURCES

---

1

Submitted to Universitas Negeri Surabaya The State University of Surabaya

Student Paper

6%

---

2

irphouse.com

Internet Source

2%

---

3

Muhamad Muslih, Nunik Destria Arianti, Somantri, Dewi Sartika Thamren, Fajri, Ramayanty Bulan. "Utilization of a Web-Based Geographic Information System for Land Mapping and Some Its Overview: A Case Study in Sukabumi District, Indonesia", International Journal of Design & Nature and Ecodynamics, 2022

Publication

1%

---

Exclude quotes Off

Exclude matches Off

Exclude bibliography On

# IJERT - Full Jurnal 131\_20519-IJERT\_DECEMBER ISSUE ok 5005-5011.pdf

---

## GRADEMARK REPORT

---

FINAL GRADE

**/0**

GENERAL COMMENTS

**Instructor**

---

PAGE 1

---

PAGE 2

---

PAGE 3

---

PAGE 4

---

PAGE 5

---

PAGE 6

---

PAGE 7

---